

**READ AND FOLLOW ALL SAFETY INSTRUCTIONS!
SAVE THESE INSTRUCTIONS AND DELIVER TO OWNER AFTER INSTALLATION**

IMPORTANT SAFETY INSTRUCTIONS

⚠ WARNING

To reduce the risk of death, injury or property damage from fire, electric shock, cuts, abrasions, falling parts, and other hazards:

- Service of the equipment must be performed by qualified service personnel.
- Installation and maintenance must be performed by a person familiar with the construction and operation of this product and any hazards involved. All applicable codes and ordinances must be followed.
- Read this document before installing, servicing, or maintaining this equipment. These instructions do not cover all installation, service, and maintenance situations. If your situation is not covered, or if you do not understand these instructions or additional information is required, contact *Synergy Lighting Controls*.

⚠ WARNING

Before installing, servicing, or maintaining this equipment, follow these general precautions.

To reduce the risk of electrocution:

- Make sure the equipment is properly grounded.
- Always de-energize any equipment before connecting to, disconnecting from, or servicing the equipment.

To reduce the risk of fire:

- Use supply conductors with a minimum installation temperature rating as specified.

To reduce the risk of personal injury from cuts, abrasions:

- Wear gloves to prevent cuts or abrasions from sharp edges when removing from carton, handling and maintaining this equipment.
- Do not install a damaged equipment.

Synergy Lighting Controls, a division of Acuity Brands Inc., assumes no responsibility for claims arising out of improper or careless installation or handling of this product.

SAVE THESE INSTRUCTIONS

Quick Setup Guide Relay Module WITHOUT BREAKERS

SEE THE FOLLOWING PAGE FOR MODULES WITH BREAKERS

Refer to the instructions on the following pages for complete details on the steps outlined below.

1

Install the Relay Modules in the Enclosure.

Install the first module in the top position as shown, then install additional modules in the positions below. Make sure the ribbon cable stays at the back of the enclosure **behind the installed modules**.

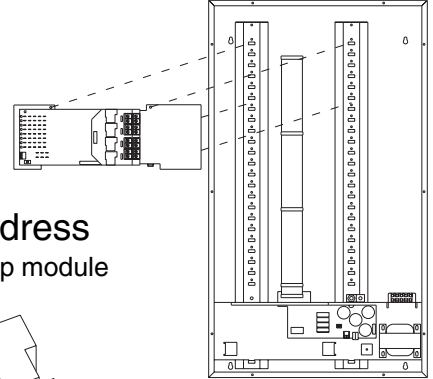

2

Set Each Module Address to a Unique Address

Rotate the address wheel to set the ID. Set the ID of the top module at "1" (as shown), the second at "2" and so on.

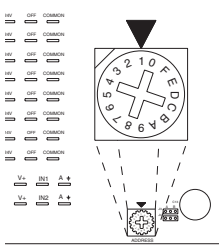

3

Connect the Ribbon Cable to Each Module

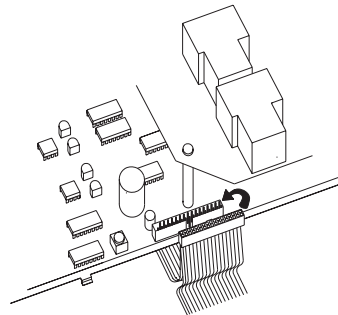

4

Test for Short Circuits in Load Wiring

Test for short circuits in load wiring **PRIOR** to connecting load to relay output terminals.

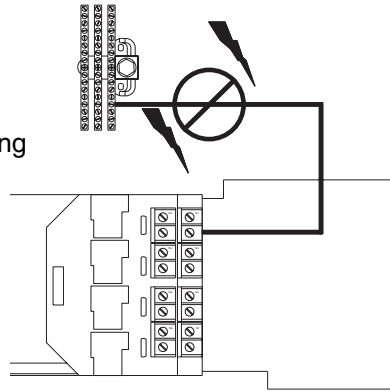

5

Connect Load Wiring as Shown in Figure 1

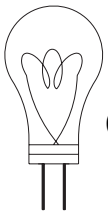

6

Test Power Module Operation

Turn on the cabinet power supply. Use the ON/AUTO/OFF switch to test the module. All module outputs should turn ON when the switch is in the right-most (ON) position and turn OFF when the switch is in the left-most (OFF) position. When testing is complete, return the switch to the AUTO (Center) position. The ON/AUTO/OFF switch **MUST** be in the AUTO position for normal system operation and control from the system controller and low voltage inputs.

7

Connect Any Low Voltage Wiring (If Required) as Shown in Figure 1

Installation Instructions

Relay Power Module - SYPM 8R



Quick Setup Guide

Relay Module WITH BREAKERS

SEE THE FOLLOWING PAGE FOR MODULES WITHOUT BREAKERS

Refer to the instructions on the following pages for complete details on the steps outlined below.

1 Install the Relay Modules in the Enclosure.

Install a neutral bar module in the top position. Install the first module in the top position as shown, then install additional modules in the positions below. Make sure the ribbon cable stays at the back of the enclosure **behind the installed modules**.

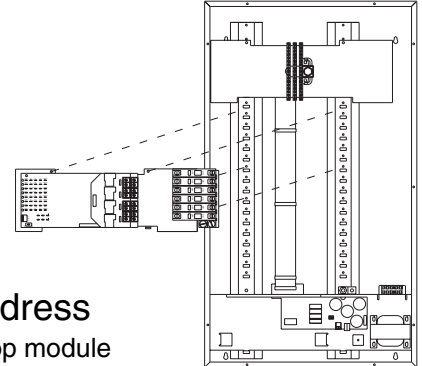

2 Set Each Module Address to a Unique Address

Rotate the address wheel to set the ID. Set the ID of the top module at "1" (as shown), the second at "2" and so on.

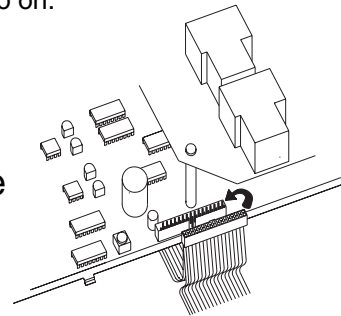
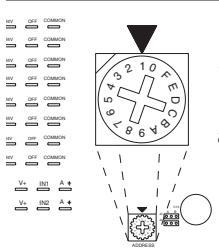

3 Connect the Ribbon Cable to Each Module

4 Connect the Power Feed Wiring to the Input Lugs

The lugs accept #14 - 2/0 AWG conductors. Use the second lug to tap feed additional modules. See Figures 2 and 3 for typical feed wiring details.

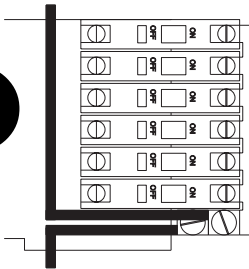

5 Test for Short Circuits in Load Wiring

Test for short circuits in load wiring **PRIOR** to connecting load to relay output terminals.

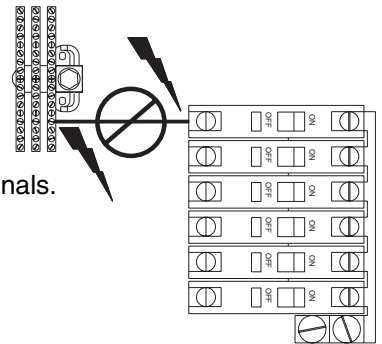

6 Connect Load Wiring as Shown in Figure 1

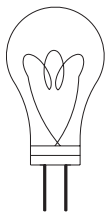

7 Test Power Module Operation

Turn on the cabinet power supply. Turn on all module circuit breakers. Use the ON/AUTO/OFF switch to test the module. All module outputs should turn ON when the switch is in the right-most (ON) position and turn OFF when the switch is in the left-most (OFF) position. When testing is complete, return the switch to the AUTO (Center) position. The ON/AUTO/OFF switch **MUST** be in the AUTO position for normal system operation and control from the system controller and low voltage inputs.

8 Connect Any Low Voltage Wiring (If Required) as Shown in Figure 1

Installation Instructions

Relay Power Module - SYPM 8R



Before You Start

1. Always disconnect all power.
2. Install in accordance with the National Electrical Code and any other codes which may apply.
3. Use only as intended and at the listed voltage.

Important Module Installation Notes

1. Install relay modules in cabinet starting at the top. **Plug ribbon cable into each module before installing the next module. Ribbon cable installs behind modules.**
2. Verify the load type is compatible with voltages, loads and capacity listed on module label.
3. Test branch circuits for short circuits **prior** to energizing module.
4. Module input and output terminal specification (1) #10, #12, #14 AWG or (2) #12, #14 AWG maximum.
5. Circuits with a fault current greater than 22k AIC should be wired with **ONLY** a single phase on each of the upper (TB2, 4, 6 & 8) or lower (TB1, 3, 5 & 7) circuit boards.
7. **DO NOT** connect 2 or 3 pole circuits or loads to these relays. Equipment warranty void if multi-pole loads are controlled directly. Use Synergy 2, 3 or 4 pole accessory relays (SYA 2POLE/3POLE/4POLE) or external contactors only.

Module Installation and Wiring

1. **MOUNT TOP MODULE**
Starting at the **TOP** of the cabinet, mount the module by setting the bottom tabs in the slots at the back of the cabinet then securing the top with the screws provided.
2. **SET MODULE ID AND CONNECT RIBBON CABLE**
Rotate the relay card ID switch to the address **1** position. (See *Figure 1*) Plug the male connector on the ribbon cable into the female socket on the relay module. **Ribbon cable installs behind the modules.**
3. Repeat steps 1 & 2 for additional modules, incrementing the relay card ID switches by 1 from the top of the cabinet down.

Module Installation and Wiring Cont.

4. **PROVIDE PRIMARY POWER WIRING & BRANCH CIRCUIT CONNECTION**
Modules without breakers:
Connect input terminal blocks TB1-TB8 to a 15 or 20 amp single pole branch breaker. A branch breaker can be connected to several module input terminals if required. Make load wiring connections per *Figure 1*.
Modules with breakers:
Connect each module input lug to an appropriately sized conductor. Use the module's feed through lug to connect additional modules to the same phase input circuit. See *Figure 1* for load connections and *Figures 2* and *3* for typical feed wiring details. Refer to Synergy supplied As-Built drawings for more details. **Test for short circuits prior to energizing module.** Torque connection to 7 inch-lbs.
5. **CONNECT LOW VOLTAGE INPUT WIRING**
Inputs from contact closures should be terminated to the male spade connectors on the relay module. (See *Figure 1*) Refer to Synergy supplied As Built drawings, accessory instructions or project specifications for details.
6. **START-UP POWER MODULES TO ALLOW MANUAL LIGHTING CONTROL**
Following this procedure step by step will reduce the chance of damage due to relay closing on a short circuit. Module warranty void if relay closes on a short circuit.
 1. Turn off all Branch Breakers
 2. Verify the "Manual Override Switch" is in the **ON** position. (See *Figure 1*)
 3. Turn on circuit breaker for the enclosure power supply.
 4. Turn on branch breakers. Use the manual override switch for convenient on/off override.
7. **RELAY MODULE CONFIGURATION**
The relay cards are fully programmable with the addition of the system controller. Refer to the system controller installation instructions and Synergy Operation Manual for more information.

Troubleshooting Procedures

If the relay outputs do not come on follow these steps:

1. Verify the correct voltage is present between the INPUT LUG and the NEUTRAL BUSS.
2. Verify the cabinet power supply LEDs are on and the RIBBON CABLE is properly connected to the power supply and the module.
3. Verify the module CIRCUIT BREAKERS are in the ON position (if applicable).
4. Verify voltage is present on the output terminal block(s) and/or the output of the CIRCUIT BREAKERS.
5. Switch the MANUAL OVERRIDE SWITCH to the "ON" position. All loads and RELAY OUTPUT STATUS LEDs should turn on.
6. If relays remain "ON" after being signaled "OFF" check the circuit for overloads. If no overload is present, program the "phase" of the output using the controller. If the loads switch on/off using the manual override switch but do not respond to the controller, check the system programming. See the Synergy Operation Manual for programming instructions.
7. After testing is complete, switch the MANUAL OVERRIDE SWITCH to the "AUTO" position.

If after performing the above tests one or more circuits still do not turn on, contact Synergy Lighting Controls Technical Service department between the hours of 8 AM and 5 PM EST, Monday - Friday, at 800-533-271

Visit Synergy Lighting Controls on the internet at <http://www.synergylightingcontrols.com> for further information on products, technical data or installation instructions.

Warranty

Synergy Lighting Controls warrants all equipment to be free from defect in manufacturing under normal and proper storage, installation, and operation for a period of one (1) year. Our guarantee liability extends only to the repair or replacement of the defective part and no labor charges for correction of the defect by repair or replacement will be honored by Synergy Lighting Controls unless prior written authorization has been granted by our Customer Service Department.

Installation Instructions

Relay Power Module - SYPM 8R

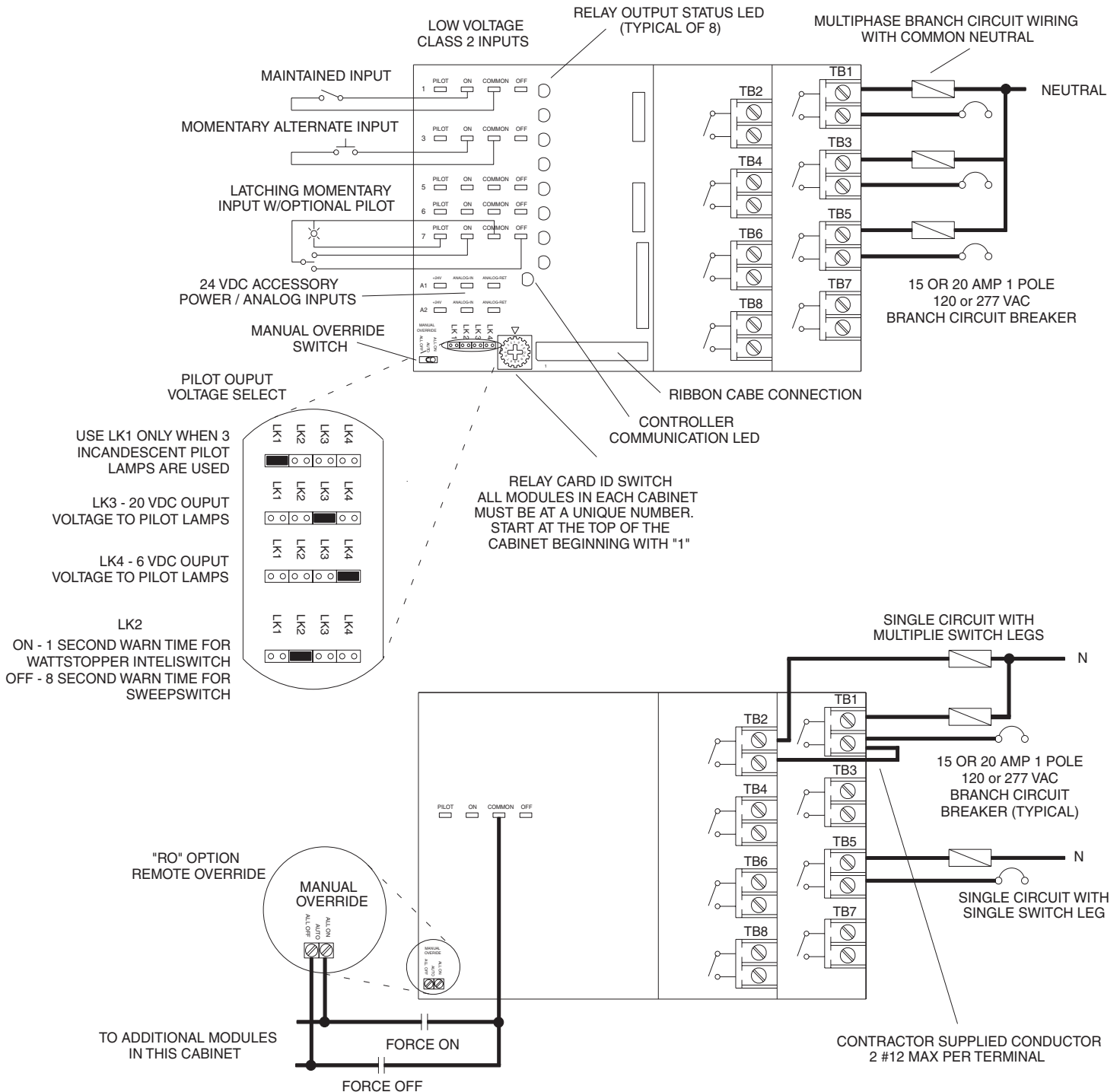
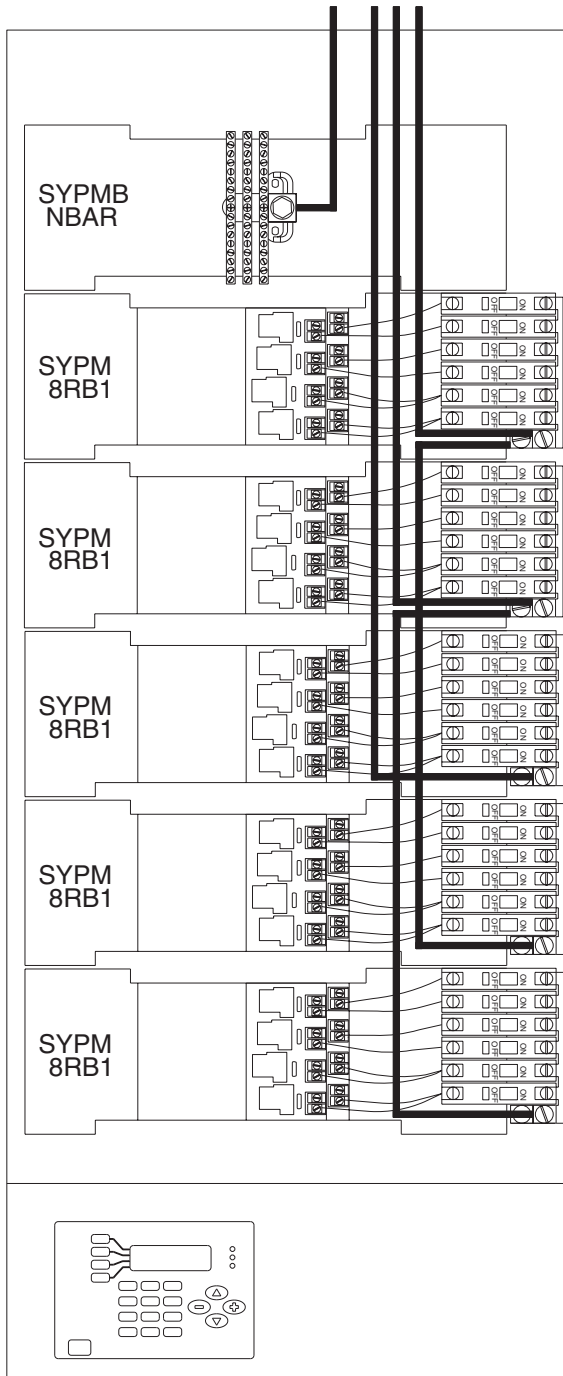
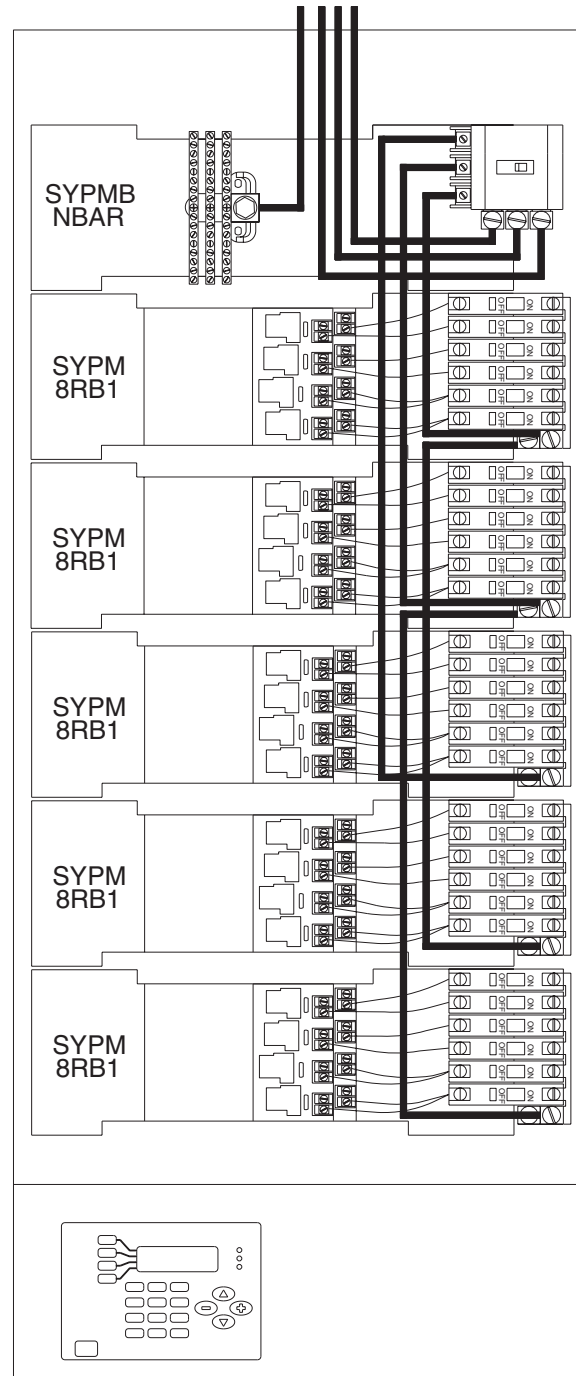

Figure 1 - SYPM 8R Wiring Detail

Three Phase Four Wire Main Feed Details



**Figure 2 - Large Enclosure Module Population
 Modules w/Breakers and Neutral Bar**



**Figure 3 - Large Enclosure Module Population
 Modules w/Breakers, Neutral Bar and Main Breaker**